



0.95-1.65um InGaAs Avalanche Photodiode in TO-46 Package APD-F13A3

Data Sheet

Features

- InGaAs Avalanche photodiode (APD) in TO-46 flat window package
- Highly reliable planar device
- High responsivity in 0.95-1.65um
- Low leakage current and noise
- ≥ 700 MHz 3dB bandwidth
- Low stray absorption

Applications

- Light detection and ranging (LIDAR)
- Fiber optic communication / testing
- Spectral analysis
- Optical coherence tomography
- Single-photodiode SWIR camera
- Covert IR sensing

Specifications

Absolute Maximum Ratings				
Parameters	Symbol	Rating	Unit	Conditions
Reverse current	I_R	1	mA	
Forward current	I_F	5	um	
Operation temperature	T_{op}	-40 to 85	°C	
Storage temperature	T_{stg}	-40 to 85	°C	

Electro-Optical Characteristics ($T_a=23^\circ\text{C}$)						
Parameters	Symbol	Min.	Typ.	Max.	Unit	Conditions
Wavelength spectral range	λ	0.95		1.65	um	
Aperture size			200		um	
Dark current	I_D		5	50	nA	M=10
Operating voltage	V_{op}	32		50	V	M=10
Breakdown voltage	V_{BD}	35		55	V	$I_{BD}=100\mu\text{A}$
Capacitance	C_J	-	2.5	3.0	pF	M=10, f=1MHz
Responsivity	I_L	8	9		A/W	M=10, $\lambda=1.55\mu\text{m}$
Useable gain		10	20	-		$\lambda=1.55\mu\text{m}$
3dB bandwidth (f_{3dB})		0.8	1		GHz	M=10, $\lambda=1.55\mu\text{m}$
Spectral noise current		-	0.5	1.5	$\text{pA}/\sqrt{\text{Hz}}$	M=10, $\Delta f=1\text{kHz}$
Temperature coefficient of V_{BD}		-	0.10	0.15	V/°C	

Typical Characteristics

Dark / Photo-Current

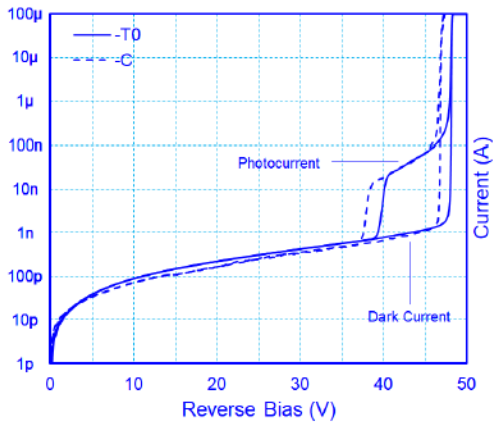

Dark Current

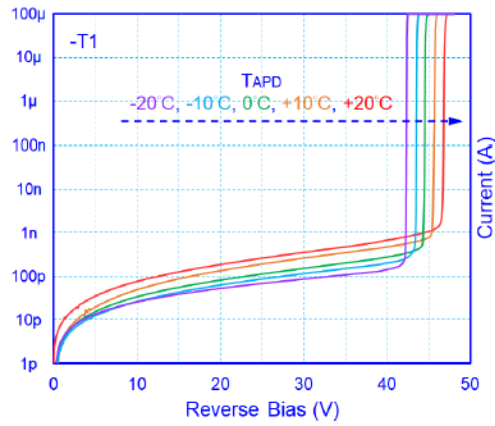

Dark Capacitance

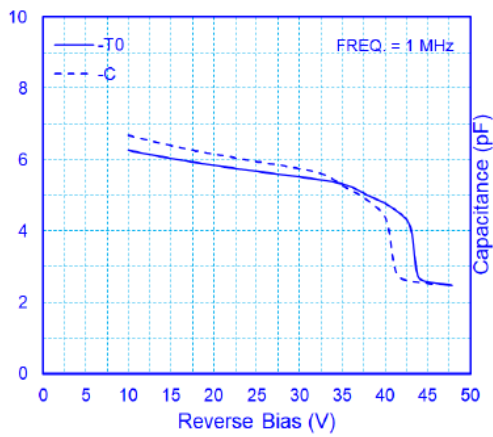

Responsivity Spectrum

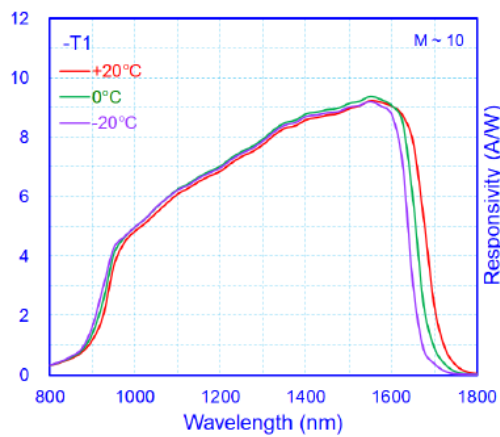

Frequency Response

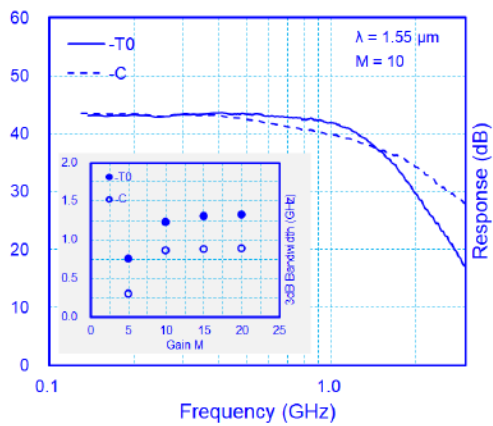

TEC Performance

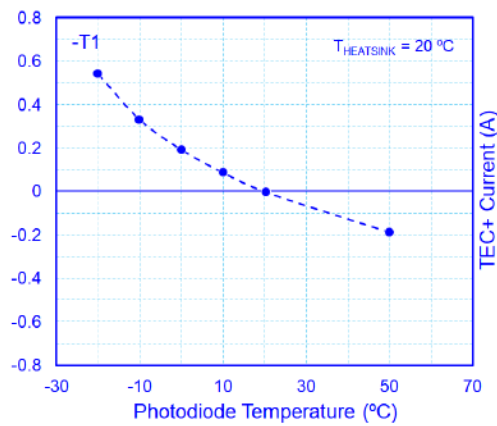

Outline Dimensions (unit: mm)

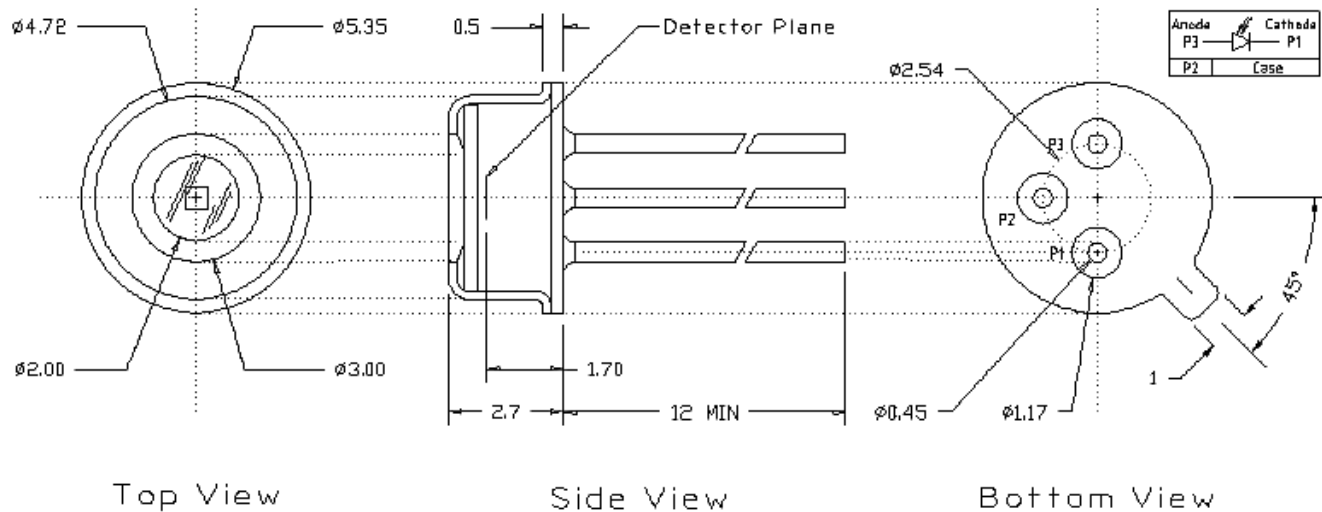

Note: Specifications are subject to change without notice.