



635nm 5mW Laser Diode, ø5.6mm Package LD635A5C15

Features

- 635nm AlGaInP Visible Laser Diode
- Optical output power: 5mW CW
- High temperature operation: 50°C
- High assembly accuracy
- Low operating current
- Package: ø5.6mm, TO-18 can

Applications

- High precision measuring instruments
- High precision industrial laser markers
- Survey and engineering instruments
- Industrial laser markers
- Laser pointer

Specifications

ABSOLUTE MAXIMUM RATINGS				
PARAMETER	SYMBOL	CONDITION	RATING	UNIT
Light output power	P_O	CW	7	mW
Reverse voltage (LD)	V_{RL}	-	2	V
Reverse voltage (PD)	V_{RD}	-	30	V
Forward current (PD)	I_{FD}	-	10	mA
Case temperature	T_C	-	-10 to +50	°C
Storage temperature	T_S	-	-40 to +85	°C

ELECTRICAL AND OPTICAL CHARACTERISTICS (TC = 25°C)						
PARAMETER	SYMBOL	MIN.	TYP.	MAX.	UNIT	CONDITIONS
Peak wavelength	λ	630	635	640	nm	$P_O = 5\text{mW}$
Threshold current	I_{th}	-	24	30	mA	
Operating current	I_{op}	-	33	40	mA	$P_O = 5\text{mW}$
Operating voltage	V_{op}	-	2.2	2.5	V	$P_O = 5\text{mW}$
Differential efficiency	η	0.4	0.6	0.8	mW/mA	$P_O = 3\text{-}5\text{mW}$
Monitor current	I_m	0.1	0.15	0.3	mA	$P_O = 5\text{mW}, V_{RD} = 5\text{V}$
Parallel divergence angle	$\Theta_{//}$	6	7.5	11	deg	$P_O = 5\text{mW}$
Perpendicular divergence angle	Θ_{\perp}	30	33	40	deg	
Parallel FFP deviation angle	$\Delta \Theta_{//}$	-2	0	+2	deg	
Perpendicular FFP deviation angle	$\Delta \Theta_{\perp}$	-2	0	+2	deg	
Emission point accuracy	$\Delta x \Delta y \Delta z$	-60	0	+60	um	

Typical Characteristics

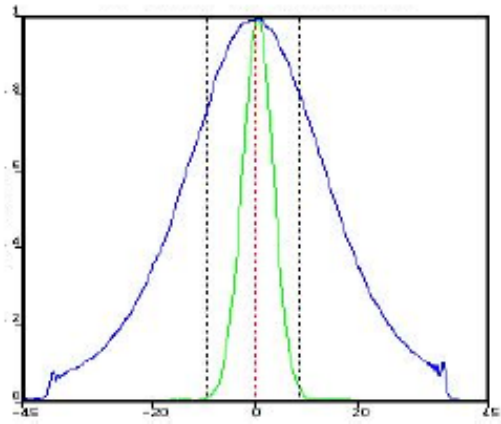
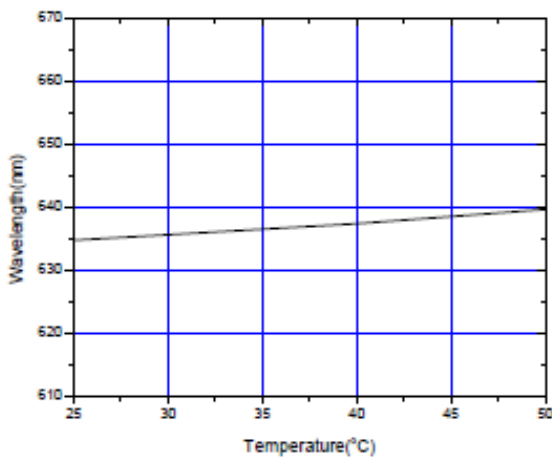
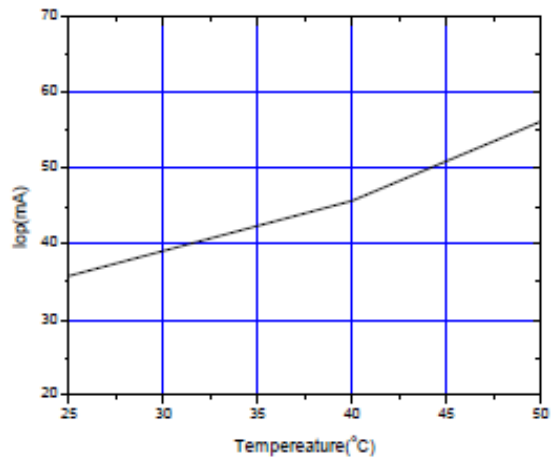
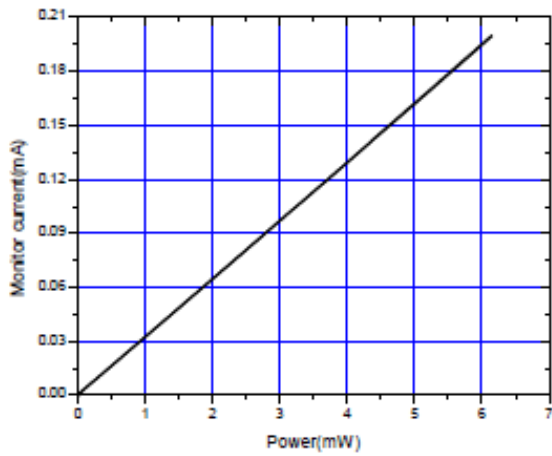
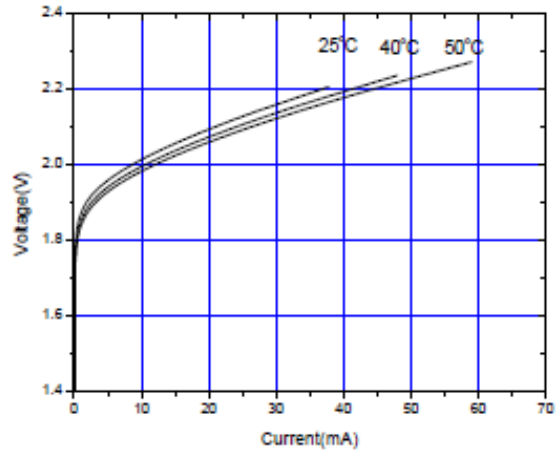
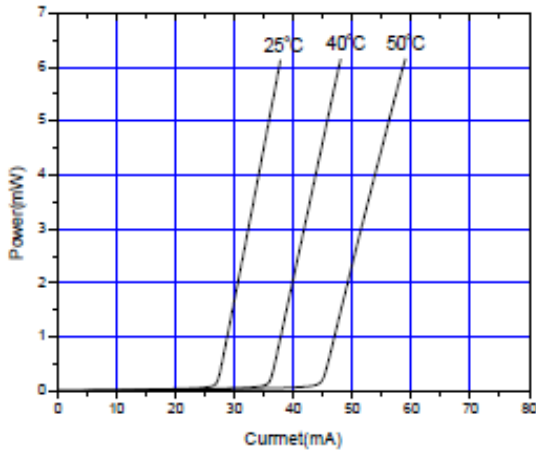

Mechanical Outline (unit: mm)

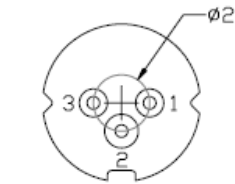
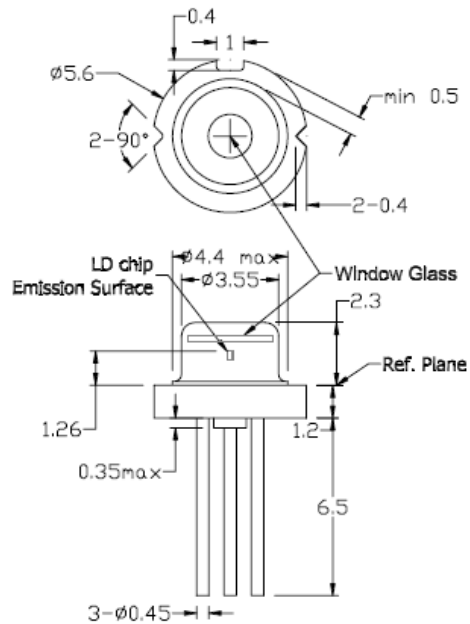

PIN CONFIGURATION

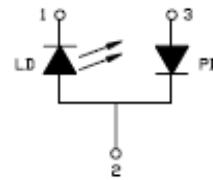

*Other pin configurations may be available upon request.

Additional Notes

- Do not operate the device above maximum ratings. Doing so may cause unexpected and permanent damage to the device.
- Take precautions to avoid electrostatic discharge and/or momentary power spikes. A change in the characteristics of the laser or premature failure may result.
- Proper heat sinking of the device assures stability and lifetime. Always ensure that maximum operating temperatures are not exceeded.
- Observing visible or invisible laser beams with human eye directly, or indirectly, can cause permanent damage. Use a camera to observe the laser.
- No laser device should be used in any application or situation where life or property is at risk in the event of device failure.
- Specifications are subject to change without notice. Ensure that you have the latest specification by contacting us prior to purchase or use of the product.