



VCAx-940P25WA

940nm 25W Multi-Channel Pulsed VCSEL Array

Description

The Lasermate VCAx-940P25WA is a 940nm wavelength, 25W output power, pulsed operating mode, multi-channel Vertical Cavity Surface Emitting Laser (VCSEL) diode array. Available with up to 16 channels, the VCSEL is characterized by its single wavelength, good thermal conduction, oxide isolation technology, high reliability, and easy collimation. Designed for 3D sensors, proximity sensor, 3D detection, scanning lidar, laser curtain, and range finder sensor applications.

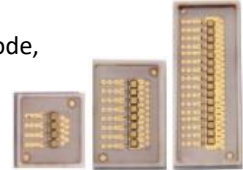

Features

- 940nm VCSEL Diode Array
- Output power: 25W (ns pulse)
- Single wavelength
- Good thermal conduction
- Short rise time
- Oxide isolation technology
- High reliability
- Easy to collimate

Applications

- 3D sensors
- Proximity sensor
- 3D detection
- Scanning lidar
- Laser curtain
- Range finder sensor

Product Overview

The following table lists the available part numbers, as well as the package type of each of the part numbers.

Part Number	Description
VCA4A-940P25WA	940nm 25W Pulsed VCSEL Diode Array, 4-Channel
VCA8A-940P25WA	940nm 25W Pulsed VCSEL Diode Array, 8-Channel
VCA16A-940P25WA	940nm 25W Pulsed VCSEL Diode Array, 16-Channel



Specifications

Absolute Maximum Ratings				
Parameters	Symbol	Rating	Unit	Conditions
Case Operating Temperature	T _{op}	-40 to 85	°C	
Storage Temperature	T _{stg}	-40 to 105	°C	
Reflow Soldering Temperature	T _{sol}	260°C	°C	10 seconds
Reverse Voltage	V _r	5	V	
Maximum Continuous Current	I _{max}	100	A	Duty cycle 0.1% max
ESD Exposure (Human Body) Model	ESD	2K	V	

Notes:

- Stresses greater than those listed under “Absolute Maximum Ratings” may cause permanent damage to the device. This is a stress rating only and functional operation of the device at these or other conditions above those indicated in the operations section for expanded periods of time may affect reliability.
- In its maximum rating diode laser operation could damage its performance or cause potential safety hazard such as equipment failure.
- Electrostatic discharge is the main reason for laser fault of the diode. Take effective precautions against ESD. When dealing with laser diodes, use wrist strap, grounding work surface and strict antistatic technology.

Electro-Optical Characteristics (T _{op} =25°C, Pulse width 8.8ns at 11.68 kHz)						
Parameters	Symbol	Min.	Typ.	Max.	Unit	Conditions
Optical Output Power	P _o	20	25	30	W	I _F =81A
Threshold Current	I _{th}	-	0.1	-	A	
Forward Pulse Current		-	81	-	A	
Emission Area		-	370x371	-	um	
Peak Wavelength	λ _p	930	940	950	nm	P _o =25W
Pulse Forward Voltage	V _F	36	37	38	V	I _F =81A
Series Resistance	R _S	0.44	0.46	0.47	Ohm	I _F =81A
Beam Angle	θ	-	20	-	Deg	I _F =81A
Wavelength Temperature Drift	Δλ _p / ΔT	-	0.07	-	nm/°C	I _F =81A
Rise Time	Tr	-	2.8	-	ns	
Soldering Temperature	T _{sol}			260	°C	10 seconds
Duty Cycle		-	-	0.1	%	

Environmental Specifications						
Parameters	Symbol	Min.	Typ.	Max.	Unit	Ref.
Case Operating Temperature	T _{op}	-40	25	85	°C	
Storage Temperature	T _{stg}	-40	25	105	°C	



Typical Characteristics

LIV Graph

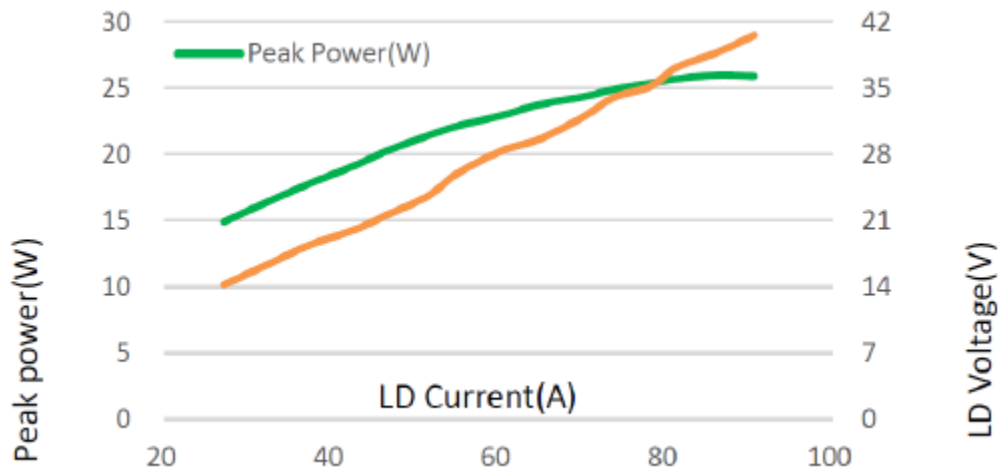

Pulse width=8.8ns

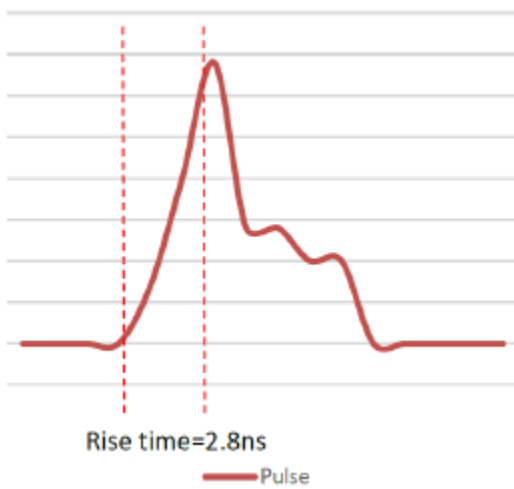

Intensity vs. Wavelength

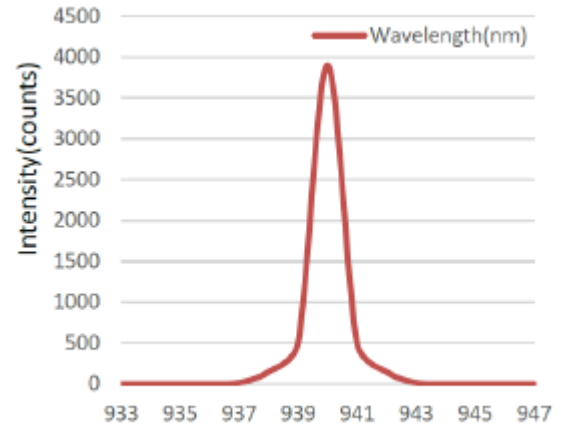

Outline Dimensions (unit: mm)

VCA4A-940P25WA (Package 1x4 Array, Substrate AlN)

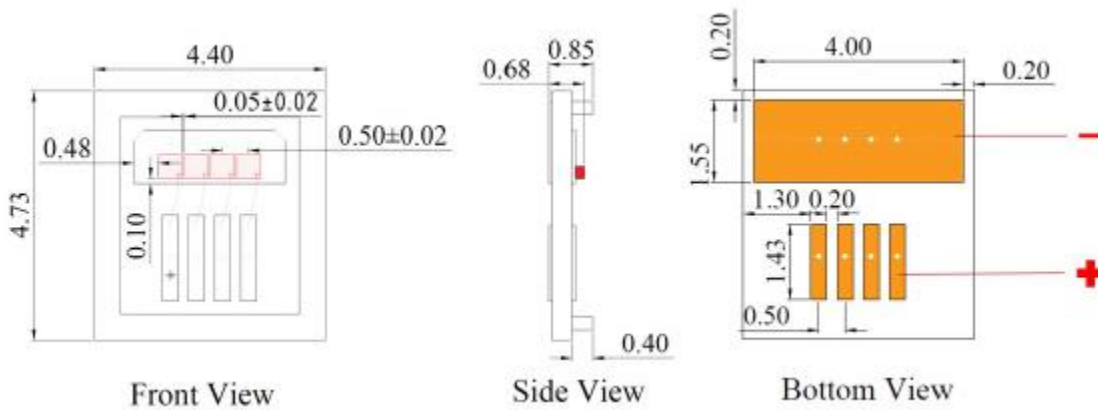

VCA8A-940P25WA (Package 1x8 Array, Substrate AlN)

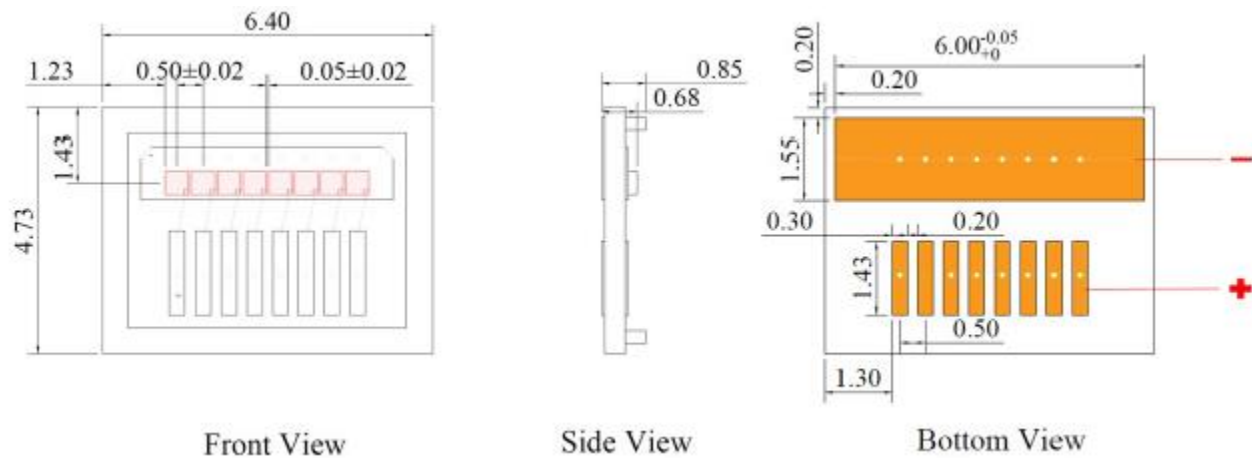

VCA16A-940P25WA (Package 1x16 Array, Substrate AlN)

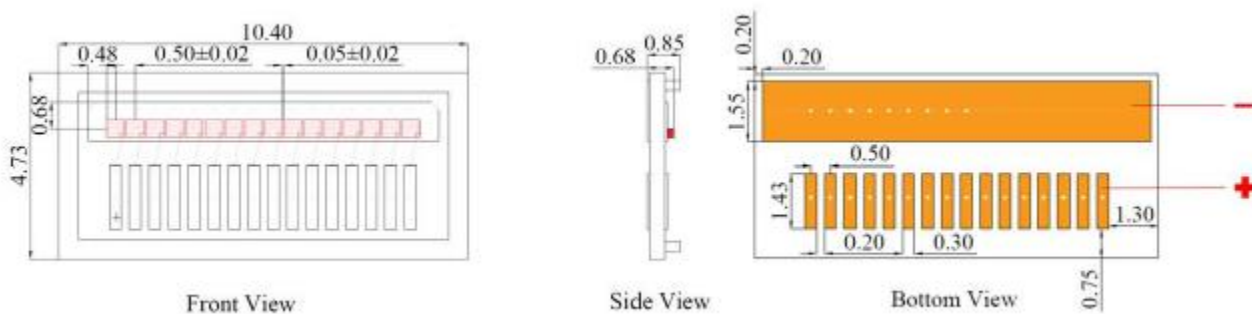



SMT Reflow Soldering Curve

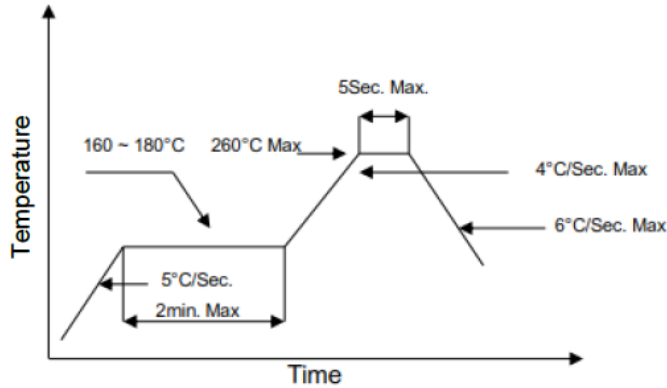

Note: Reflow soldering can be operated only one time. During the temperature ramp-up, no forces may be exerted on the LD which would deform or damage them. After soldering is completed, please do not process until the product temperature ramps down to room temperature.

Additional Notes

1. Please use solder paste to cure the laser diode.
2. Please make sure that the heat of VCSEL diode has been completely conducted to metal shell to avoid affecting the optical power output.
3. This VCSEL diode can be only used in constant voltage and current.
4. Please do not aim the laser at people or animals.
5. You may observe the laser spot through an image monitoring equipment.
6. Please do not touch VCSEL diode surface by naked hands or squeeze the sealant on VCSEL diode surface. It may cause wrong optical angle and distorted laser spot, and even damage the VCSEL diode.
7. Please use ceramic suction nozzle to absorb the VCSEL diode, so as to avoid VCSEL diode sticking to the nozzle.
8. Please add a 0.02s blowing action after locating the laser diode to aluminum substrate.
9. Specifications are subject to change without notice.