



LDH980CxWI

980nm CW Microchannel Water-Cooled Horizontal Diode Laser Stack

Description

The LDH980CxWI is an 980nm wavelength, five-bar horizontal linear diode laser array providing up to 100W/bar CW and generating output powers up to 500W. The CW diode laser array employs micro-channels and enables water-cooling. The diode laser array is designed to provide the highest reliability and efficiency in pumping, industrial and medical applications.



Features

- 980nm Micro-Channel Water-Cooled Horizontal Linear Array
- 5 bars (Up to 100W CW/bar)
- High output power: Up to 500W CW
- Spectral width: <5 nm
- High reliability
- High efficiency

Applications

- Pumping
- Industrial
- Medical

Product Overview

The following table lists the available part numbers, as well as the total output power, output power per bar, number of bars, and cooling method of each of the part numbers.

Part Number	Total Output Power	Output Power per Bar	Number of Bars	Cooling Method
LDH980C200WI	200W	40W	5	Microchannel Water-Cooled
LDH980C300WI	300W	60W	5	Microchannel Water-Cooled
LDH980C400WI	400W	80W	5	Microchannel Water-Cooled
LDH980C500WI	500W	100W	5	Microchannel Water-Cooled



Specifications (T_c = 25°C)

Optical Characteristics						
Parameter	Symbol	Value				Unit
Center wavelength	λ_c	980				nm
Operation mode		CW				-
Output power	P _o	200	300	400	500	W
Output power/bar	P _o /bar	40	60	80	100	W
Spectral width	$\Delta\lambda$	<5				nm
Bar quantity		5				-
Fast axis divergence	θ_{\perp}	<39				deg
Slow axis divergence	θ_{\parallel}	<10				deg
Electrical Characteristics						
Parameter	Symbol	Value				Unit
Threshold current	I _{th}	<7	<15	<25	<25	A
Operating current	I _{op}	<40	<70	<95	<110	A
Operating voltage/bar	V _{op}	<2.0	<2.0	<2.0	<2.0	V
Thermal Characteristics						
Parameter	Symbol	Value				Unit
Max. inlet pressure		65				psi
Cooling rate/bar		≥0.3				1/min
Cooling medium particle size		≤15				μm
Cooling medium conductivity		5 to 10				μs/cm
Operating temperature	T _{op}	15 to 35				°C
Storage temperature	T _{stg}	-10 to +60				°C

Mechanical Outline (unit: mm)

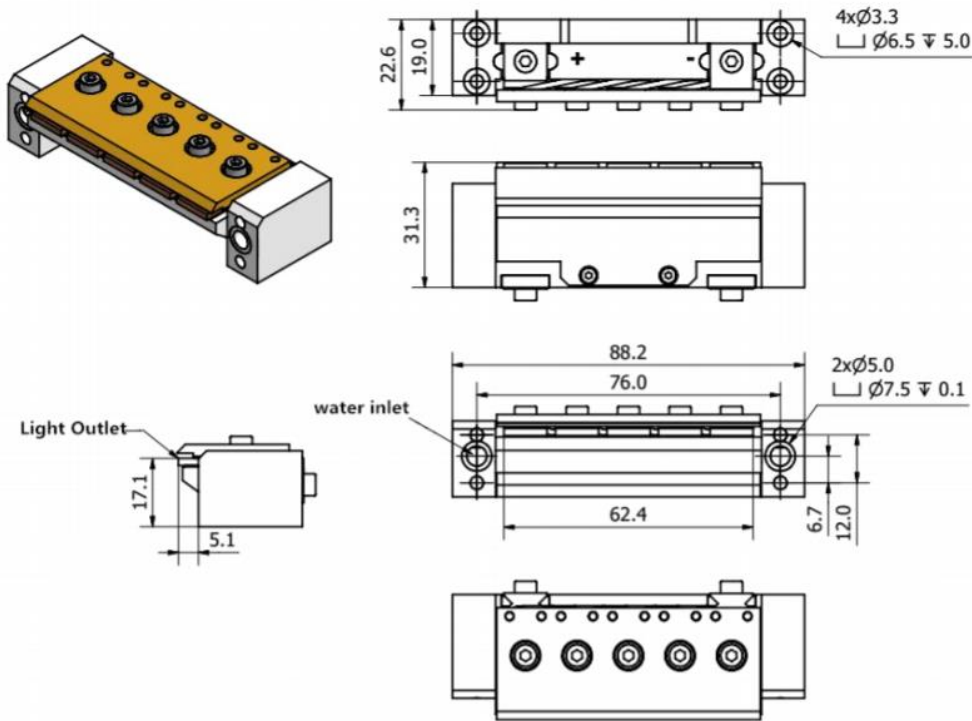

Notes

- Specifications are subject to change without notice. Ensure that you have the latest specification by contacting us prior to purchase or use of the product.
- Please make sure that the laser diode is operated under the temperature between 15 °C and 35 °C, as high temperature will increase threshold current, decrease exchange rate and accelerate the aging.
- Please take measures to avoid condensation, which will cause aging of laser diode.
- Take precautions to avoid electrostatic discharge and/or momentary power spikes. A change in the characteristics of the laser or premature failure may result.
- Observing visible or invisible laser beams with human eye directly, or indirectly, can cause permanent damage. Do not look directly into the laser output port.