



940nm 1000mW CW VCSEL Diode with Diffuser, 3535 SMD Package

VCD35A-940C1Wx



Description

The Lasermate VCD35A-940C1Wx is an 940nm wavelength, 1000mW output power, CW operating mode, Vertical Cavity Surface Emitting Laser (VCSEL) diode with diffuser in surface mount (SMD) package designed for use in sensing applications.

Features

- Surface mount SMD package with Diffuser
- Single wavelength
- Low threshold current
- Oxide isolation technology
- Small emission area
- Easy to collimate
- 1000mW 940nm VCSEL @ 1.30A

Applications

- 3D sensors
- Gesture recognition
- IR illumination
- Medical application
- Broadband access network

Product Overview

The following table lists the available part numbers, as well as the package type and diffuser beam angle of each of the part numbers.

Part Number	Package	Diffuser Beam Angle
VCD35A-940C1WA	3535 Package, Substrate AlN	60°x45°
VCD35A-940C1WB	3535 Package, Substrate AlN	72°x58°
VCD35A-940C1WC	3535 Package, Substrate AlN	90°x70°
VCD35A-940C1WD	3535 Package, Substrate AlN	110°x85°
VCD35A-940C1WE	3535 Package, Substrate AlN	120°x90°

Specifications

Absolute Maximum Ratings				
Parameters	Symbol	Rating	Unit	Conditions
Case Operating Temperature	Top	-40 to 85	°C	
Storage Temperature	Tstg	-40 to 105	°C	
Reflow Soldering Temperature	Tsol	260	°C	10 seconds
Reverse Voltage	Vr	4	V	
Maximum Continuous Current	I _{max}	2	A	
ESD Exposure (Human Body) Model	ESD	2k-4k (Class 2)	V	
ESD Exposure (Machine) Model	ESD	200-400 (Class B)		

Notes:

- Stresses greater than those listed under “Absolute Maximum Ratings” may cause permanent damage to the device. This is a stress rating only and functional operation of the device at these or other conditions above those indicated in the operations section for expanded periods of time may affect reliability.
- In its maximum rating diode laser operation could damage its performance or cause potential safety hazard such as equipment failure.
- Electrostatic discharge is the main reason for laser fault of the diode. Take effective precautions against ESD. When dealing with laser diodes, use wrist strap, grounding work surface and strict antistatic technology.

Electro-Optical Characteristics (T _{op} =25°C, CW mode)						
Parameters	Symbol	Min.	Typ.	Max.	Unit	Conditions
Optical Output Power	P _o	-	1000	-	mW	I _F =1.30A
Threshold Current	I _{th}	-	0.2	-	A	
Forward Current		-	1.30	-	A	
Peak Wavelength	λ _p	930	940	950	nm	I _F =1.30A
Forward Voltage	V _F	-	2.17	-	V	I _F =1.30A
Power Conversion Efficiency	PCE	-	35	-	%	I _F =1.30A
Spectral Width	FWHM _s	-	2.8	-	nm	
Slope Efficiency	η	-	0.82	-	W/A	P _o =1000mW
Series Resistance	R _s	-	0.50	-	Ω	I _F =1.30A
Wavelength Temperature Drift	Δλ _p / ΔT	-	-	0.07	nm/°C	I _F =1.30A
Number of Emission Aperture			20			

Note: Electro-optical characteristic with a package or diffuser would require further evaluation. Values are based on limited sample size and estimated values.

Typical Characteristics

LIV Graph

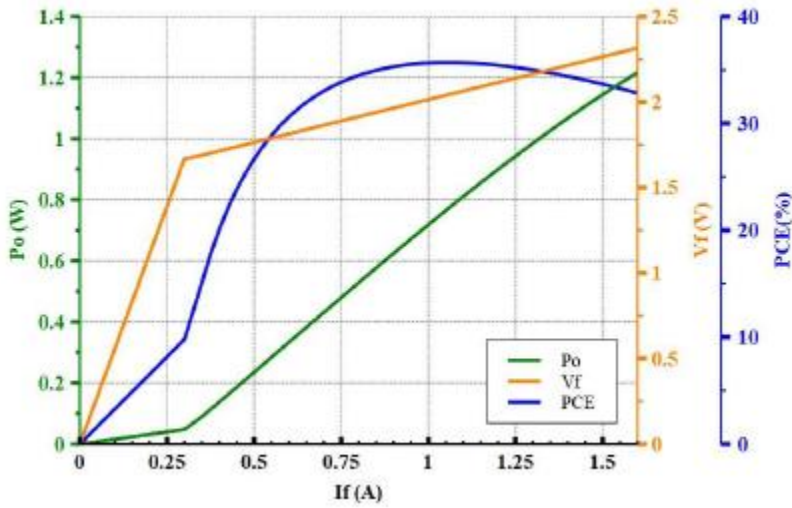

Intensity vs. Wavelength

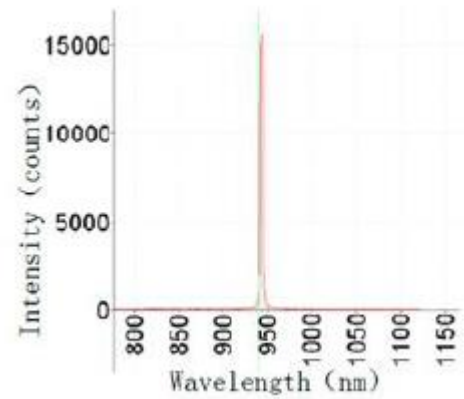

Typical Beam Profile with Diffuser

Beam angle: 60°x45°

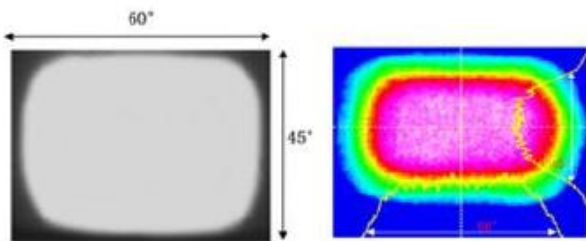

Beam angle: 72°x58°

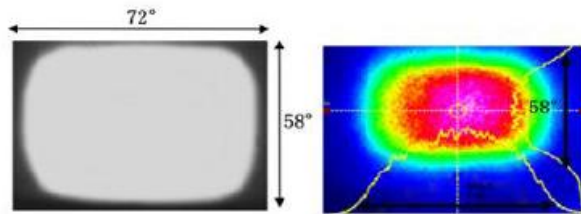

Beam angle: 90°x70°

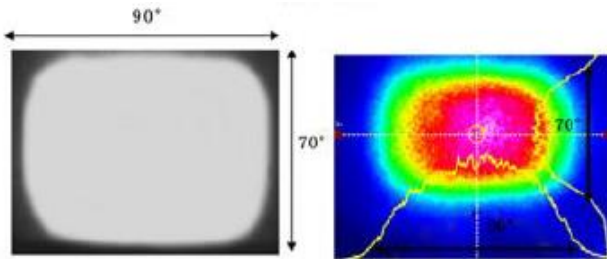

Beam angle: 110°x85°

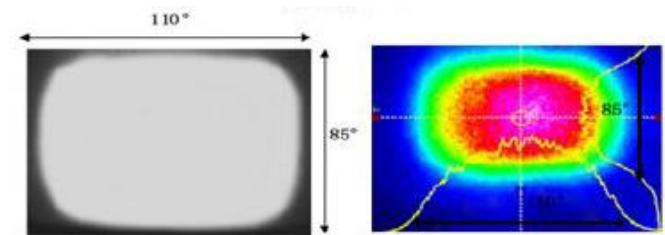

Beam angle: 120°x90°

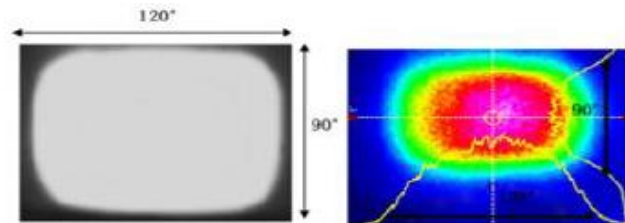

Outline Dimensions (unit: mm)

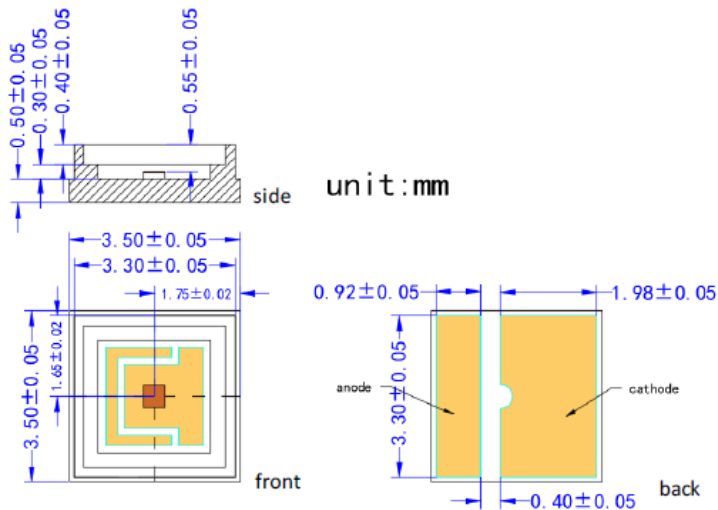

SMT Reflow Soldering Curve

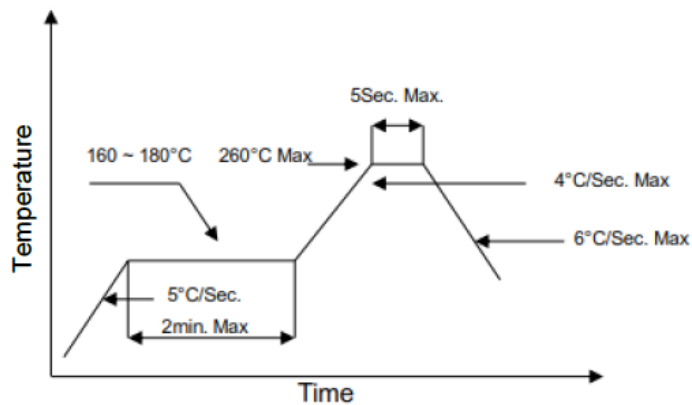

Note: Reflow soldering can be operated only one time. During the temperature ramp-up, no forces may be exerted on the LD which would deform or damage them. After soldering is completed, please do not process until the product temperature ramps down to room temperature.

Additional Notes

1. Please use solder paste to cure the laser diode.
2. Please make sure that the heat of VCSEL diode has been completely conducted to metal shell to avoid affecting the optical power output.
3. This VCSEL diode can be only used in constant voltage and current.
4. Please do not aim the laser at people or animals.
5. You may observe the laser spot through an image monitoring equipment.
6. Please do not touch VCSEL diode surface by naked hands or squeeze the sealant on VCSEL diode surface. It may cause wrong optical angle and distorted laser spot, and even damage the VCSEL diode.
7. Please use ceramic suction nozzle to absorb the VCSEL diode, so as to avoid VCSEL diode sticking to the nozzle.
8. Please add a 0.02s blowing action after locating the laser diode to aluminum substrate.
9. Specifications are subject to change without notice.



Lasermate Group, Inc.
19608 Camino De Rosa
Walnut, CA 91789 USA
Tel: (909)718-0999
Fax: (909)718-0998
sales@lasermate.com
www.lasermate.com